



DATOS MOTOR

POTENCIA	2HP
REVOLUCIONES	1760
FRECUENCIA	60HZ
TORQUE MOTOR NOMINAL	8,3
CARCASA (PAM)	100(B5)
TIPO BRIDA	FF-215
EFICIENCIA MOTOR	IE 2

DATOS REDUCTOR

REFERENCIA	541023
TIPO	ORTOGONAL
MODELO	FCNDK
MATERIAL	HIERRO
CARCASA	130
RELACION DE TRANSMISION i:	100
VELOCIDAD SALIDA	17,60
TORQUE MAXIMO	700
TORQUE OPERACIÓN	531
FACTOR DE SERVICIO	1,3

PLANOS REDUCTOR

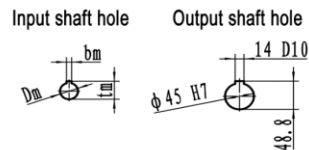
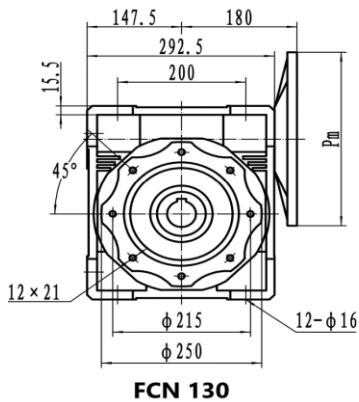

	Pm	Dm	bm	tm
90B5	200	24	8	27.3
90B14	140			
100/112B5	250	28	8	31.3
100/112B14	160			
132B5	300	38	10	41.3
132B14	200			

